

Z370 AORUS Gaming K3

User's Manual

Rev. 1001

12ME-Z37AGK3-1001R



For more product details, please visit GIGABYTE's website.



To reduce the impacts on global warming, the packaging materials of this product are recyclable and reusable. GIGABYTE works with you to protect the environment.

Declaration of Conformity

We, Manufacturer/Importer,

G.B.T. Technology Trading GmbH

Address: Bullenkoppel 16, 22047 Hamburg, Germany

Declare that the product

Product Type: **Motherboard**

Product Name: **Z370 AORUS Gaming K3**

conforms with the essential requirements of the following directives:

EMC Directive 2014/30/EU:

- | | |
|--|---------------------------|
| <input checked="" type="checkbox"/> Conduction & Radiated Emissions: | EN 55022:2010/AC2011 |
| <input checked="" type="checkbox"/> Immunity: | EN 55024:2010 |
| <input checked="" type="checkbox"/> Power-line harmonics: | EN 61000-3-2:2006+A2:2009 |
| <input checked="" type="checkbox"/> Power-line flicker: | EN 61000-3-3:2013 |

Low Voltage Directive 2014/35/EU:

- | | |
|---|--|
| <input checked="" type="checkbox"/> Safety: | EN60950-1:2006+A11:2009+A12:2011+A2:2013 |
|---|--|

RoHS Directive 2011/65/EU

- | | |
|---|--|
| <input checked="" type="checkbox"/> Restriction of use of certain substances in electronic equipment: | This product does not contain any of the restricted substances listed in Annex II, in concentrations and applications banned by the directive. |
|---|--|

CE marking



Signature: Timmy Huang

(stamp)

Date: Sept. 1, 2017

Name: Timmy Huang

DECLARATION OF CONFORMITY

Per FCC Part 2 Section 2.1077(a)



Responsible Party Name: **G.B.T. INC. (U.S.A.)**

Address: **17358 Railroad Street
City of Industry, CA 91748**

Phone/Fax No: **(626) 854-9338/ (626) 854-9326**

hereby declares that the product

Product Name: Motherboard

Model Number: Z370 AORUS Gaming K3

Conforms to the following specifications:

FCC Part 15, Subpart B, Section 15.107(a) and Section 15.109 (a), Class B Digital Device

Supplementary Information:

This device complies with part 15 of the FCC Rules. Operation is subject to the following two conditions: (1) This device may not cause harmful and (2) this device must accept any interference received, including that may cause undesired operation.

Representative Person's Name: ERIC LU

Signature: Eric Lu

Date: Sept. 1, 2017

Copyright

© 2017 GIGABYTE TECHNOLOGY CO., LTD. All rights reserved.

The trademarks mentioned in this manual are legally registered to their respective owners.

Disclaimer

Information in this manual is protected by copyright laws and is the property of GIGABYTE.

Changes to the specifications and features in this manual may be made by GIGABYTE without prior notice.

No part of this manual may be reproduced, copied, translated, transmitted, or published in any form or by any means without GIGABYTE's prior written permission.

- For quick set-up of the product, read the Quick Installation Guide included with the product.
- In order to assist in the use of this product, carefully read the User's Manual.
- For product-related information, check on our website at: <http://www.gigabyte.com>

Identifying Your Motherboard Revision

The revision number on your motherboard looks like this: "REV: X.X." For example, "REV: 1.0" means the revision of the motherboard is 1.0. Check your motherboard revision before updating motherboard BIOS, drivers, or when looking for technical information.

Example:

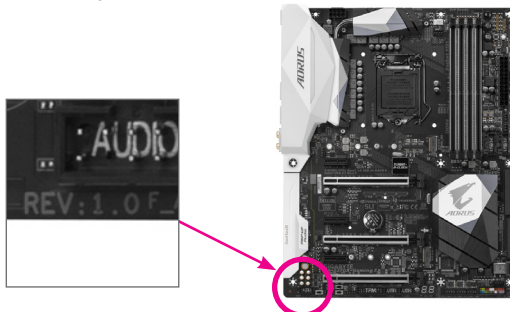
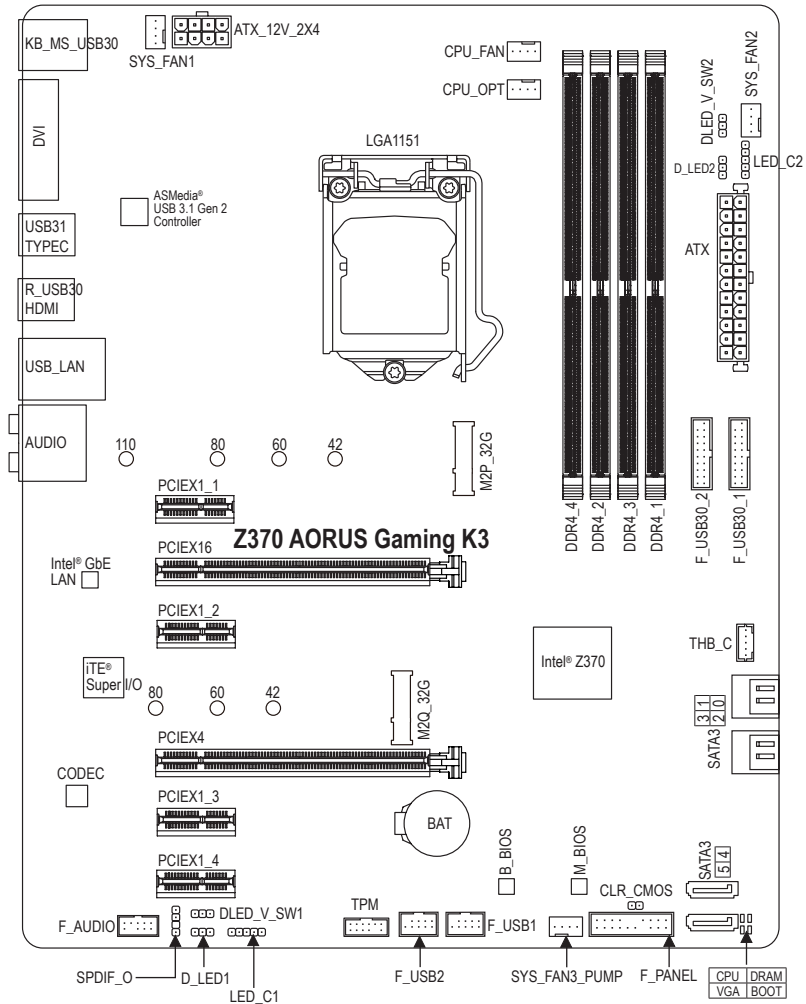

Table of Contents

Z370 AORUS Gaming K3 Motherboard Layout.....	4
Chapter 1 Hardware Installation	5
1-1 Installation Precautions	5
1-2 Product Specifications.....	6
1-3 Installing the CPU	9
1-4 Installing the Memory	9
1-5 Installing an Expansion Card	10
1-6 Back Panel Connectors.....	10
1-7 Internal Connectors.....	12
Chapter 2 BIOS Setup	21
2-1 Startup Screen	21
2-2 M.I.T.	22
2-3 System	28
2-4 BIOS.....	29
2-5 Peripherals	32
2-6 Chipset.....	35
2-7 Power	36
2-8 Save & Exit.....	38
Chapter 3 Appendix	39
3-1 Configuring a RAID Set.....	39
3-2 Installing an Intel® Optane™ Memory.....	41
3-3 Drivers Installation.....	43
Regulatory Statements.....	44
Contact Us	48

Z370 AORUS Gaming K3 Motherboard Layout



Box Contents

- Z370 AORUS Gaming K3 motherboard
- Motherboard driver disk
- User's Manual
- Quick Installation Guide
- Four SATA cables
- I/O Shield
- One G Connector

* The box contents above are for reference only and the actual items shall depend on the product package you obtain. The box contents are subject to change without notice.









Chapter 1 Hardware Installation





1-1 Installation Precautions





The motherboard contains numerous delicate electronic circuits and components which can become damaged as a result of electrostatic discharge (ESD). Prior to installation, carefully read the user's manual and follow these procedures:

- Prior to installation, make sure the chassis is suitable for the motherboard.
- Prior to installation, do not remove or break motherboard S/N (Serial Number) sticker or warranty sticker provided by your dealer. These stickers are required for warranty validation.
- Always remove the AC power by unplugging the power cord from the power outlet before installing or removing the motherboard or other hardware components.
- When connecting hardware components to the internal connectors on the motherboard, make sure they are connected tightly and securely.
- When handling the motherboard, avoid touching any metal leads or connectors.
- It is best to wear an electrostatic discharge (ESD) wrist strap when handling electronic components such as a motherboard, CPU or memory. If you do not have an ESD wrist strap, keep your hands dry and first touch a metal object to eliminate static electricity.
- Prior to installing the motherboard, please have it on top of an antistatic pad or within an electrostatic shielding container.
- Before connecting or unplugging the power supply cable from the motherboard, make sure the power supply has been turned off.
- Before turning on the power, make sure the power supply voltage has been set according to the local voltage standard.
- Before using the product, please verify that all cables and power connectors of your hardware components are connected.
- To prevent damage to the motherboard, do not allow screws to come in contact with the motherboard circuit or its components.
- Make sure there are no leftover screws or metal components placed on the motherboard or within the computer casing.
- Do not place the computer system on an uneven surface.
- Do not place the computer system in a high-temperature or wet environment.
- Turning on the computer power during the installation process can lead to damage to system components as well as physical harm to the user.
- If you are uncertain about any installation steps or have a problem related to the use of the product, please consult a certified computer technician.
- If you use an adapter, extension power cable, or power strip, ensure to consult with its installation and/or grounding instructions.

1-2 Product Specifications

	CPU	<ul style="list-style-type: none"> ◆ Support for 8th Generation Intel® Core™ i7 processors/Intel® Core™ i5 processors/Intel® Core™ i3 processors in the LGA1151 package (Go to GIGABYTE's website for the latest CPU support list.) ◆ L3 cache varies with CPU
	Chipset	<ul style="list-style-type: none"> ◆ Intel® Z370 Express Chipset
	Memory	<ul style="list-style-type: none"> ◆ 4 x DDR4 DIMM sockets supporting up to 64 GB of system memory ◆ Dual channel memory architecture ◆ Support for DDR4 2666/2400/2133 MHz memory modules ◆ Support for ECC Un-buffered DIMM 1Rx8/2Rx8 memory modules (operate in non-ECC mode) ◆ Support for non-ECC Un-buffered DIMM 1Rx8/2Rx8/1Rx16 memory modules ◆ Support for Extreme Memory Profile (XMP) memory modules (Go to GIGABYTE's website for the latest supported memory speeds and memory modules.)
	Onboard Graphics	<ul style="list-style-type: none"> ◆ Integrated Graphics Processor-Intel® HD Graphics support: <ul style="list-style-type: none"> - 1 x DVI-D port, supporting a maximum resolution of 1920x1200@60 Hz <ul style="list-style-type: none"> * The DVI-D port does not support D-Sub connection by adapter. - 1 x HDMI port, supporting a maximum resolution of 4096x2160@30 Hz <ul style="list-style-type: none"> * Support for HDMI 1.4 version and HDCP 2.2. ◆ Maximum shared memory of 1 GB
	Audio	<ul style="list-style-type: none"> ◆ Realtek® ALC1220 codec ◆ High Definition Audio ◆ 2/4/5.1/7.1-channel ◆ Support for S/PDIF Out
	LAN	<ul style="list-style-type: none"> ◆ Intel® GbE LAN chip (10/100/1000 Mbit)
	Expansion Slots	<ul style="list-style-type: none"> ◆ 1 x PCI Express x16 slot, running at x16 (PCIEX16) <ul style="list-style-type: none"> * For optimum performance, if only one PCI Express graphics card is to be installed, be sure to install it in the PCIEX16 slot. ◆ 1 x PCI Express x16 slot, running at x4 (PCIEX4) <ul style="list-style-type: none"> * The PCIEX4 slot shares bandwidth with the PCIEX1_2, 3, 4 slots. The PCIEX4 slot operates at up to x1 mode when the PCIEX1_2, 3, or 4 slot is populated. ◆ 4 x PCI Express x1 slots (All of the PCI Express slots conform to PCI Express 3.0 standard.)
	Multi-Graphics Technology	<ul style="list-style-type: none"> ◆ Support for AMD Quad-GPU CrossFire™ and 2-Way AMD CrossFire™ technologies
	Storage Interface	<ul style="list-style-type: none"> ◆ Chipset: <ul style="list-style-type: none"> - 1 x M.2 connector (Socket 3, M key, type 2242/2260/2280/22110 SATA and PCIe x4/x2 SSD support) (M2P_32G) - 1 x M.2 connector (Socket 3, M key, type 2242/2260/2280 PCIe x4/x2 SSD support) (M2Q_32G) - 6 x SATA 6Gb/s connectors - Support for RAID 0, RAID 1, RAID 5, and RAID 10 <ul style="list-style-type: none"> * Refer to "1-7 Internal Connectors," for the installation notices for the M.2 and SATA connectors. ◆ Intel® Optane™ Memory Ready

	USB	<ul style="list-style-type: none"> ◆ Chipset+ASMedia® USB 3.1 Gen 2 Controller: <ul style="list-style-type: none"> - 1 x USB Type-C™ port on the back panel, with USB 3.1 Gen 2 support - 1 x USB 3.1 Gen 2 Type-A port (red) on the back panel ◆ Chipset: <ul style="list-style-type: none"> - 8 x USB 3.1 Gen 1 ports (4 ports on the back panel, 4 ports available through the internal USB headers) - 6 x USB 2.0/1.1 ports (2 ports on the back panel, 4 ports available through the internal USB headers)
	Internal Connectors	<ul style="list-style-type: none"> ◆ 1 x 24-pin ATX main power connector ◆ 1 x 8-pin ATX 12V power connector ◆ 2 x M.2 Socket 3 connectors ◆ 6 x SATA 6Gb/s connectors ◆ 1 x CPU fan header ◆ 1 x water cooling CPU fan header ◆ 2 x system fan headers ◆ 1 x system fan/water cooling pump header ◆ 2 x digital LED strip headers ◆ 2 x digital LED strip power select jumpers ◆ 2 x RGB (RGBW) LED strip headers ◆ 1 x front panel header ◆ 1 x front panel audio header ◆ 2 x USB 3.1 Gen 1 headers ◆ 2 x USB 2.0/1.1 headers ◆ 1 x S/PDIF Out header ◆ 1 x Trusted Platform Module (TPM) header (2x6 pin, for the GC-TPM2.0_S module only) ◆ 1 x Thunderbolt™ add-in card connector ◆ 1 x Clear CMOS jumper
	Back Panel Connectors	<ul style="list-style-type: none"> ◆ 1 x PS/2 keyboard/mouse port ◆ 1 x DVI-D port ◆ 1 x HDMI port ◆ 1 x USB Type-C™ port, with USB 3.1 Gen 2 support ◆ 1 x USB 3.1 Gen 2 Type-A port (red) ◆ 4 x USB 3.1 Gen 1 ports ◆ 2 x USB 2.0/1.1 ports ◆ 1 x RJ-45 port ◆ 6 x audio jacks (Center/Subwoofer Speaker Out, Rear Speaker Out, Side Speaker Out, Line In, Line Out, Mic In)
	I/O Controller	<ul style="list-style-type: none"> ◆ iTE® I/O Controller Chip
	Hardware Monitor	<ul style="list-style-type: none"> ◆ Voltage detection ◆ Temperature detection ◆ Fan speed detection ◆ Water cooling flow rate detection ◆ Overheating warning ◆ Fan fail warning ◆ Fan speed control <ul style="list-style-type: none"> * Whether the fan (pump) speed control function is supported will depend on the fan (pump) you install.

	BIOS	<ul style="list-style-type: none"> ◆ 2 x 128 Mbit flash ◆ Use of licensed AMI UEFI BIOS ◆ Support for DualBIOS™ ◆ PnP 1.0a, DMI 2.7, WfM 2.0, SM BIOS 2.7, ACPI 5.0
	Unique Features	<ul style="list-style-type: none"> ◆ Support for APP Center <ul style="list-style-type: none"> * Available applications in APP Center may vary by motherboard model. Supported functions of each application may also vary depending on motherboard specifications. - 3D OSD - @BIOS - AutoGreen - BIOS Setup - Color Temperature - Cloud Station - EasyTune - Easy RAID - Fast Boot - Game Boost - ON/OFF Charge - Platform Power Management - RGB Fusion - Smart Backup - Smart Keyboard - Smart TimeLock - System Information Viewer - USB Blocker - V-Tuner ◆ Support for Q-Flash ◆ Support for Xpress Install
	Bundled Software	<ul style="list-style-type: none"> ◆ Norton® Internet Security (OEM version) ◆ cFosSpeed
	Operating System	<ul style="list-style-type: none"> ◆ Support for Windows 10 64-bit
	Form Factor	<ul style="list-style-type: none"> ◆ ATX Form Factor; 30.5cm x 24.4cm

* GIGABYTE reserves the right to make any changes to the product specifications and product-related information without prior notice.



Please visit GIGABYTE's website for support lists of CPU, memory modules, SSDs, and M.2 devices.



Please visit the **SupportUtility List** page on GIGABYTE's website to download the latest version of apps.

1-3 Installing the CPU



Read the following guidelines before you begin to install the CPU:

- Make sure that the motherboard supports the CPU.
(Go to GIGABYTE's website for the latest CPU support list.)
- Always turn off the computer and unplug the power cord from the power outlet before installing the CPU to prevent hardware damage.
- Locate the pin one of the CPU. The CPU cannot be inserted if oriented incorrectly. (Or you may locate the notches on both sides of the CPU and alignment keys on the CPU socket.)
- Apply an even and thin layer of thermal grease on the surface of the CPU.
- Do not turn on the computer if the CPU cooler is not installed, otherwise overheating and damage of the CPU may occur.
- Set the CPU host frequency in accordance with the CPU specifications. It is not recommended that the system bus frequency be set beyond hardware specifications since it does not meet the standard requirements for the peripherals. If you wish to set the frequency beyond the standard specifications, please do so according to your hardware specifications including the CPU, graphics card, memory, hard drive, etc.

Installing the CPU

Locate the alignment keys on the motherboard CPU socket and the notches on the CPU.

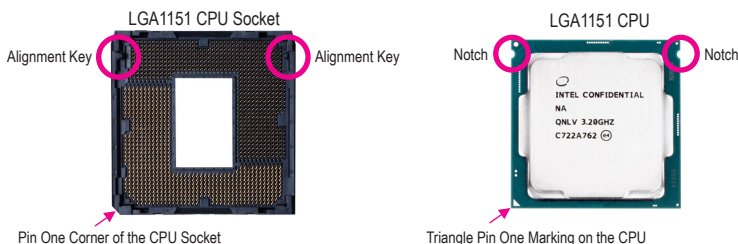

Do not remove the CPU socket cover before inserting the CPU. It may pop off from the load plate automatically during the process of re-engaging the lever after you insert the CPU.

1-4 Installing the Memory



Read the following guidelines before you begin to install the memory:

- Make sure that the motherboard supports the memory. It is recommended that memory of the same capacity, brand, speed, and chips be used.
(Go to GIGABYTE's website for the latest supported memory speeds and memory modules.)
- Always turn off the computer and unplug the power cord from the power outlet before installing the memory to prevent hardware damage.
- Memory modules have a foolproof design. A memory module can be installed in only one direction. If you are unable to insert the memory, switch the direction.

Dual Channel Memory Configuration

This motherboard provides four memory sockets and supports Dual Channel Technology. After the memory is installed, the BIOS will automatically detect the specifications and capacity of the memory. Enabling Dual Channel memory mode will double the original memory bandwidth.



Please visit GIGABYTE's website for details on hardware installation.

The four memory sockets are divided into two channels and each channel has two memory sockets as following:

▶▶ Channel A: DDR4_2, DDR4_4

▶▶ Channel B: DDR4_1, DDR4_3

▶▶ Dual Channel Memory Configurations Table

	DDR4_4	DDR4_2	DDR4_3	DDR4_1
2 Modules	--	DS/SS	--	DS/SS
	DS/SS	--	DS/SS	--
4 Modules	DS/SS	DS/SS	DS/SS	DS/SS

(SS=Single-Sided, DS=Double-Sided, "--"=No Memory)

Due to CPU limitations, read the following guidelines before installing the memory in Dual Channel mode.

1. Dual Channel mode cannot be enabled if only one memory module is installed.
2. When enabling Dual Channel mode with two or four memory modules, it is recommended that memory of the same capacity, brand, speed, and chips be used.

1-5 Installing an Expansion Card



Read the following guidelines before you begin to install an expansion card:

- Make sure the motherboard supports the expansion card. Carefully read the manual that came with your expansion card.
- Always turn off the computer and unplug the power cord from the power outlet before installing an expansion card to prevent hardware damage.

1-6 Back Panel Connectors

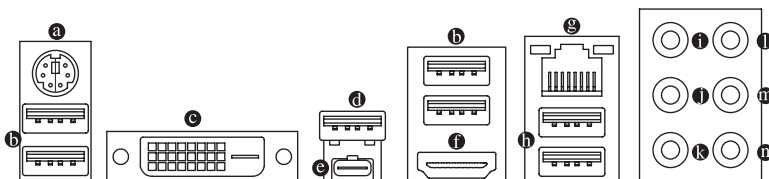

a PS/2 Keyboard/Mouse Port

Use this port to connect a PS/2 mouse or keyboard.

b USB 3.1 Gen 1 Port

The USB 3.1 Gen 1 port supports the USB 3.1 Gen 1 specification and is compatible to the USB 2.0 specification. Use this port for USB devices.

c DVI-D Port (Note)

The DVI-D port conforms to the DVI-D specification and supports a maximum resolution of 1920x1200@60 Hz (the actual resolutions supported depend on the monitor being used). Connect a monitor that supports DVI-D connection to this port.

d USB 3.1 Gen 2 Type-A Port (Red)

The USB 3.1 Gen 2 Type-A port supports the USB 3.1 Gen 2 specification and is compatible to the USB 3.1 Gen 1 and USB 2.0 specification. Use this port for USB devices.

e USB Type-C™ Port

The reversible USB port supports the USB 3.1 Gen 2 specification and is compatible to the USB 3.1 Gen 1 and USB 2.0 specification. Use this port for USB devices.

(Note) The DVI-D port does not support D-Sub connection by adapter.

① HDMI Port



The HDMI port supports HDCP 2.2 and Dolby TrueHD and DTS HD Master Audio formats. It also supports up to 192KHz/16bit 8-channel LPCM audio output. You can use this port to connect your HDMI-supported monitor. The maximum supported resolution is 4096x2160@30 Hz, but the actual resolutions supported are dependent on the monitor being used.



After installing the HDMI device, make sure to set the default sound playback device to HDMI. (The item name may differ depending on your operating system.)

② RJ-45 LAN Port

The Gigabit Ethernet LAN port provides Internet connection at up to 1 Gbps data rate. The following describes the states of the LAN port LEDs.

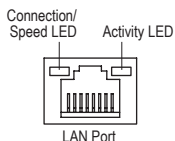

Connection/Speed LED:	
State	Description
Orange	1 Gbps data rate
Green	100 Mbps data rate
Off	10 Mbps data rate

Activity LED:	
State	Description
Blinking	Data transmission or receiving is occurring
On	No data transmission or receiving is occurring

③ USB 2.0/1.1 Port

The USB port supports the USB 2.0/1.1 specification. Use this port for USB devices.

① Center/Subwoofer Speaker Out (Orange)

Use this audio jack to connect center/subwoofer speakers in a 5.1/7.1-channel audio configuration.

② Rear Speaker Out (Black)

This jack can be used to connect rear speakers in a 4/5.1/7.1-channel audio configuration.

③ Side Speaker Out (Gray)

Use this audio jack to connect side speakers in a 7.1-channel audio configuration.

④ Line In (Blue)

The line in jack. Use this audio jack for line in devices such as an optical drive, walkman, etc.

⑤ Line Out (Green)

The line out jack. This jack supports audio amplifying function. For better sound quality, it is recommended that you connect your headphone/speaker to this jack (actual effects may vary by the device being used). Use this audio jack for a headphone or 2-channel speaker. This jack can be used to connect front speakers in a 4/5.1/7.1-channel audio configuration.

⑥ Mic In (Pink)

The Mic in jack.



- To enable or configure the audio amplifying function for the Line out jack, please access the HD Audio Manager application.
- Please visit GIGABYTE's website for more audio software information.



- When removing the cable connected to a back panel connector, first remove the cable from your device and then remove it from the motherboard.
- When removing the cable, pull it straight out from the connector. Do not rock it side to side to prevent an electrical short inside the cable connector.

1-7 Internal Connectors

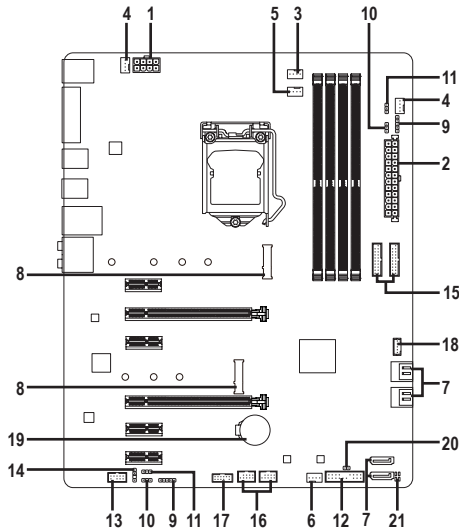

1) ATX_12V_2X4	12) F_PANEL
2) ATX	13) F_AUDIO
3) CPU_FAN	14) SPDIF_O
4) SYS_FAN1/2	15) F_USB30_1/F_USB30_2
5) CPU_OPT	16) F_USB1/F_USB2
6) SYS_FAN3_PUMP	17) TPM
7) SATA3 0/1/2/3/4/5	18) THB_C
8) M2P_32G/M2Q_32G	19) BAT
9) LED_C1/LED_C2	20) CLR_CMOS
10) D_LED1/D_LED2	21) CPU/VGA/DRAM/BOOT
11) DLED_V_SW1/DLED_V_SW2	



Read the following guidelines before connecting external devices:

- First make sure your devices are compliant with the connectors you wish to connect.
- Before installing the devices, be sure to turn off the devices and your computer. Unplug the power cord from the power outlet to prevent damage to the devices.
- After installing the device and before turning on the computer, make sure the device cable has been securely attached to the connector on the motherboard.

1/2) ATX_12V_2X4/ATX (2x4 12V Power Connector and 2x12 Main Power Connector)

With the use of the power connector, the power supply can supply enough stable power to all the components on the motherboard. Before connecting the power connector, first make sure the power supply is turned off and all devices are properly installed. The power connector possesses a foolproof design. Connect the power supply cable to the power connector in the correct orientation.

The 12V power connector mainly supplies power to the CPU. If the 12V power connector is not connected, the computer will not start.



To meet expansion requirements, it is recommended that a power supply that can withstand high power consumption be used (500W or greater). If a power supply is used that does not provide the required power, the result can lead to an unstable or unbootable system.

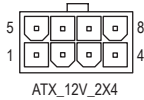

ATX_12V_2X4:

Pin No.	Definition	Pin No.	Definition
1	GND (Only for 2x4-pin 12V)	5	+12V (Only for 2x4-pin 12V)
2	GND (Only for 2x4-pin 12V)	6	+12V (Only for 2x4-pin 12V)
3	GND	7	+12V
4	GND	8	+12V

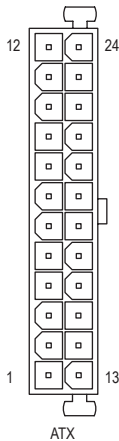

ATX:

Pin No.	Definition	Pin No.	Definition
1	3.3V	13	3.3V
2	3.3V	14	-12V
3	GND	15	GND
4	+5V	16	PS_ON (soft On/Off)
5	GND	17	GND
6	+5V	18	GND
7	GND	19	GND
8	Power Good	20	NC
9	5VSB (stand by +5V)	21	+5V
10	+12V	22	+5V
11	+12V (Only for 2x12-pin ATX)	23	+5V (Only for 2x12-pin ATX)
12	3.3V (Only for 2x12-pin ATX)	24	GND (Only for 2x12-pin ATX)

3/4) CPU_FAN/SYS_FAN1/2 (Fan Headers)

All fan headers on this motherboard are 4-pin. Most fan headers possess a foolproof insertion design. When connecting a fan cable, be sure to connect it in the correct orientation (the black connector wire is the ground wire). The speed control function requires the use of a fan with fan speed control design. For optimum heat dissipation, it is recommended that a system fan be installed inside the chassis.



Pin No.	Definition
1	GND
2	Voltage Speed Control
3	Sense
4	PWM Speed Control



- Be sure to connect fan cables to the fan headers to prevent your CPU and system from overheating. Overheating may result in damage to the CPU or the system may hang.
- These fan headers are not configuration jumper blocks. Do not place a jumper cap on the headers.

5) CPU_OPT (Water Cooling CPU Fan Header)

The fan header is 4-pin and possesses a foolproof insertion design. Most fan headers possess a foolproof insertion design. When connecting a fan cable, be sure to connect it in the correct orientation (the black connector wire is the ground wire). The speed control function requires the use of a fan with fan speed control design.



Pin No.	Definition
1	GND
2	Voltage Speed Control
3	Sense
4	PWM Speed Control

6) SYS_FAN3_PUMP (System Fan/Water Cooling Pump Header)

The pump header is 4-pin and possesses a foolproof insertion design. Most fan headers possess a foolproof insertion design. When connecting a fan cable, be sure to connect it in the correct orientation (the black connector wire is the ground wire). The speed control function requires the use of a fan with fan speed control design. For optimum heat dissipation, it is recommended that a system fan be installed inside the chassis. The header also provides speed control for a water cooling pump, refer to Chapter 2, "BIOS Setup," "M.I.T.," for more information.



Pin No.	Definition
1	GND
2	Voltage Speed Control
3	Sense
4	PWM Speed Control

7) SATA3 0/1/2/3/4/5 (SATA 6Gb/s Connectors)

The SATA connectors conform to SATA 6Gb/s standard and are compatible with SATA 3Gb/s and SATA 1.5Gb/s standard. Each SATA connector supports a single SATA device. The Intel® Chipset supports RAID 0, RAID 1, RAID 5, and RAID 10. Refer to Chapter 3, "Configuring a RAID Set," for instructions on configuring a RAID array.

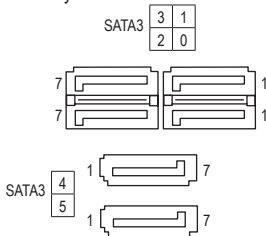

Pin No.	Definition
1	GND
2	TXP
3	TXN
4	GND
5	RXN
6	RXP
7	GND



To enable hot-plugging for the SATA ports, refer to Chapter 2, "BIOS Setup," "Peripherals\SATA And RST Configuration," for more information.

8) M2P_32G/M2Q_32G (M.2 Socket 3 Connectors)

The M.2 connectors support M.2 SATA SSDs or M.2 PCIe SSDs and support RAID configuration. Please note that an M.2 PCIe SSD cannot be used to create a RAID set either with an M.2 SATA SSD or a SATA hard drive. To create a RAID array with an M.2 PCIe SSD, you must set up the configuration in UEFI BIOS mode. Refer to Chapter 3, "Configuring a RAID Set," for instructions on configuring a RAID array.

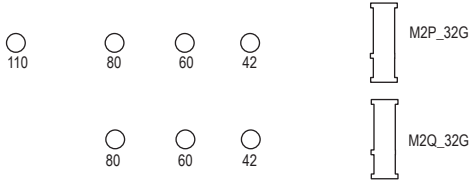

Follow the steps below to correctly install an M.2 SSD in the M.2 connector.

Step 1:

Use a screw driver to unfasten the screw and nut from the motherboard. Locate the proper mounting hole for the M.2 SSD to be installed and then screw the nut first.

Step 2:

Slide the M.2 SSD into the connector at an angle.

Step 3:

Press the M.2 SSD down and then secure it with the screw.



Select the proper hole for the M.2 SSD to be installed and refasten the screw and nut.

Installation Notices for the M.2 and SATA Connectors:

Due to the limited number of lanes provided by the Chipset, the availability of the SATA connectors may be affected by the type of device installed in the M2P_32G connector. The M2P_32G connector shares bandwidth with the SATA3 0 connector. Refer to the following tables for details.

• M2P_32G:

Type of M.2 SSD \ Connector	SATA3 0	SATA3 1	SATA3 2	SATA3 3	SATA3 4	SATA3 5
M.2 SATA SSD	✗	✓	✓	✓	✓	✓
M.2 PCIe SSD	✓	✓	✓	✓	✓	✓
No M.2 SSD Installed	✓	✓	✓	✓	✓	✓

✓ : Available, ✗ : Not available

• M2Q_32G:

Type of M.2 SSD \ Connector	SATA3 0	SATA3 1	SATA3 2	SATA3 3	SATA3 4	SATA3 5
M.2 PCIe SSD*	✓	✓	✓	✓	✓	✓
No M.2 SSD Installed	✓	✓	✓	✓	✓	✓

✓ : Available, ✗ : Not available

* The M2Q_32G connector supports only PCIe SSDs.

9) LED_C1/LED_C2 (RGB (RGBW) LED Strip Headers)

The headers can be used to connect a standard 5050 RGB (RGBW) LED strip (12V/G/R/B/W), with maximum power rating of 2A (12V) and maximum length of 2m.

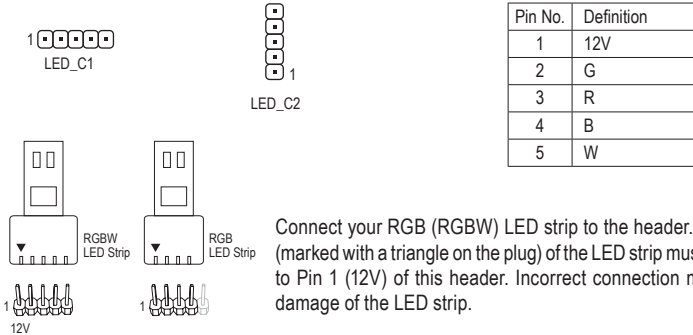

Connect your RGB (RGBW) LED strip to the header. The power pin (marked with a triangle on the plug) of the LED strip must be connected to Pin 1 (12V) of this header. Incorrect connection may lead to the damage of the LED strip.



For how to turn on/off the lights of the LED strip, refer to the instructions on in Chapter 2, "BIOS Setup," "Peripherals."



Before installing the devices, be sure to turn off the devices and your computer. Unplug the power cord from the power outlet to prevent damage to the devices.

10) D_LED1/D_LED2 (Digital LED Strip Headers)

The headers can be used to connect a standard 5050 digital LED strip, with maximum power rating of 2A (12V or 5V) and maximum length of 5m or maximum number of 300 LEDs.

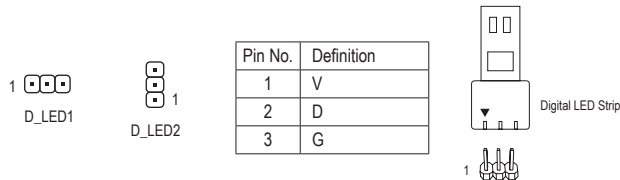

Connect your digital LED strip to the header. There are 12V and 5V digital LED strips. Be sure to verify the voltage requirements of your digital LED strips and set the DLED_V_SW1 and DLED_V_SW2 jumpers accordingly. The power pin (marked with a triangle on the plug) of the LED strip must be connected to Pin 1 of the digital LED strip header. Incorrect connection may lead to the damage of the LED strip.



For how to turn on/off the lights of the LED strip, refer to the instructions on in Chapter 2, "BIOS Setup," "Peripherals."



Before installing the devices, be sure to turn off the devices and your computer. Unplug the power cord from the power outlet to prevent damage to the devices.

11) DLED_V_SW1/DLED_V_SW2 (Digital LED Strip Power Select Jumpers)

The jumpers allow you to select the supply voltage of the D_LED1 and D_LED2 headers. Be sure to verify the voltage requirements of your digital LED strip and set the correct voltage with this jumper before connection. Incorrect connection may lead to the damage of the LED strip.

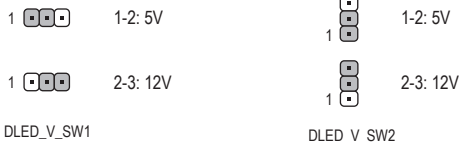

12) F_PANEL (Front Panel Header)

Connect the power switch, reset switch, speaker, chassis intrusion switch/sensor and system status indicator on the chassis to this header according to the pin assignments below. Note the positive and negative pins before connecting the cables.

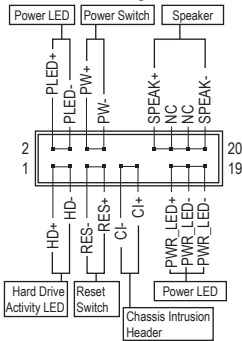

- **PLED/PWR_LED (Power LED, Yellow/Purple):**

System Status	LED
S0	On
S3/S4/S5	Off

Connects to the power status indicator on the chassis front panel. The LED is on when the system is operating. The LED is off when the system is in S3/S4 sleep state or powered off (S5).

- **PW (Power Switch, Red):**

Connects to the power switch on the chassis front panel. You may configure the way to turn off your system using the power switch (refer to Chapter 2, "BIOS Setup," "Power," for more information).

- **SPEAK (Speaker, Orange):**

Connects to the speaker on the chassis front panel. The system reports system startup status by issuing a beep code. One single short beep will be heard if no problem is detected at system startup.

- **HD (Hard Drive Activity LED, Blue):**

Connects to the hard drive activity LED on the chassis front panel. The LED is on when the hard drive is reading or writing data.

- **RES (Reset Switch, Green):**

Connects to the reset switch on the chassis front panel. Press the reset switch to restart the computer if the computer freezes and fails to perform a normal restart.

- **CI (Chassis Intrusion Header, Gray):**

Connects to the chassis intrusion switch/sensor on the chassis that can detect if the chassis cover has been removed. This function requires a chassis with a chassis intrusion switch/sensor.

- **NC (Orange):** No Connection.



The front panel design may differ by chassis. A front panel module mainly consists of power switch, reset switch, power LED, hard drive activity LED, speaker and etc. When connecting your chassis front panel module to this header, make sure the wire assignments and the pin assignments are matched correctly.

13) F_AUDIO (Front Panel Audio Header)

The front panel audio header supports Intel High Definition audio (HD). You may connect your chassis front panel audio module to this header. Make sure the wire assignments of the module connector match the pin assignments of the motherboard header. Incorrect connection between the module connector and the motherboard header will make the device unable to work or even damage it.



Pin No.	Definition
1	MIC2_L
2	GND
3	MIC2_R
4	NC
5	LINE2_R
6	Sense
7	FAUDIO_JD
8	No Pin
9	LINE2_L
10	Sense



Some chassis provide a front panel audio module that has separated connectors on each wire instead of a single plug. For information about connecting the front panel audio module that has different wire assignments, please contact the chassis manufacturer.

14) SPDIF_O (S/PDIF Out Header)

This header supports digital S/PDIF Out and connects a S/PDIF digital audio cable (provided by expansion cards) for digital audio output from your motherboard to certain expansion cards like graphics cards and sound cards. For example, some graphics cards may require you to use a S/PDIF digital audio cable for digital audio output from your motherboard to your graphics card if you wish to connect an HDMI display to the graphics card and have digital audio output from the HDMI display at the same time. For information about connecting the S/PDIF digital audio cable, carefully read the manual for your expansion card.



Pin No.	Definition
1	5VDUAL
2	No Pin
3	SPDIFO
4	GND

15) F_USB30_1/F_USB30_2 (USB 3.1 Gen 1 Headers)

The headers conform to USB 3.1 Gen 1 and USB 2.0 specification and each header can provide two USB ports. For purchasing the optional 3.5" front panel that provides two USB 3.1 Gen 1 ports, please contact the local dealer.

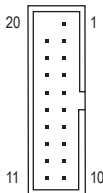

Pin No.	Definition	Pin No.	Definition
1	VBUS	11	D2+
2	SSRX1-	12	D2-
3	SSRX1+	13	GND
4	GND	14	SSTX2+
5	SSTX1-	15	SSTX2-
6	SSTX1+	16	GND
7	GND	17	SSRX2+
8	D1-	18	SSRX2-
9	D1+	19	VBUS
10	NC	20	No Pin



Prior to installing the USB front panel, be sure to turn off your computer and unplug the power cord from the power outlet to prevent damage to the USB front panel.

16) F_USB1/F_USB2 (USB 2.0/1.1 Headers)

The headers conform to USB 2.0/1.1 specification. Each USB header can provide two USB ports via an optional USB bracket. For purchasing the optional USB bracket, please contact the local dealer.

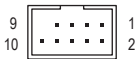

Pin No.	Definition	Pin No.	Definition
1	Power (5V)	6	USB DY+
2	Power (5V)	7	GND
3	USB DX-	8	GND
4	USB DY-	9	No Pin
5	USB DX+	10	NC



- Do not plug the IEEE 1394 bracket (2x5-pin) cable into the USB 2.0/1.1 header.
- Prior to installing the USB bracket, be sure to turn off your computer and unplug the power cord from the power outlet to prevent damage to the USB bracket.

17) TPM (Trusted Platform Module Header)

You may connect a TPM (Trusted Platform Module) to this header.

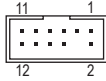

Pin No.	Definition	Pin No.	Definition
1	LAD0	7	LAD3
2	VCC3	8	GND
3	LAD1	9	LFRAME
4	No Pin	10	NC
5	LAD2	11	SERIRQ
6	LCLK	12	LRESET

18) THB_C (Thunderbolt™ Add-in Card Connector)

This connector is for a GIGABYTE Thunderbolt™ add-in card.



Supports a Thunderbolt™ add-in card.

19) BAT (Battery)

The battery provides power to keep the values (such as BIOS configurations, date, and time information) in the CMOS when the computer is turned off. Replace the battery when the battery voltage drops to a low level, or the CMOS values may not be accurate or may be lost.

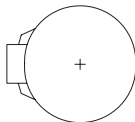

You may clear the CMOS values by removing the battery:

1. Turn off your computer and unplug the power cord.
2. Gently remove the battery from the battery holder and wait for one minute. (Or use a metal object like a screwdriver to touch the positive and negative terminals of the battery holder, making them short for 5 seconds.)
3. Replace the battery.
4. Plug in the power cord and restart your computer.



- Always turn off your computer and unplug the power cord before replacing the battery.
- Replace the battery with an equivalent one. Damage to your devices may occur if the battery is replaced with an incorrect model.
- Contact the place of purchase or local dealer if you are not able to replace the battery by yourself or uncertain about the battery model.
- When installing the battery, note the orientation of the positive side (+) and the negative side (-) of the battery (the positive side should face up).
- Used batteries must be handled in accordance with local environmental regulations.

20) CLR_CMOS (Clear CMOS Jumper)

Use this jumper to clear the BIOS configuration and reset the CMOS values to factory defaults. To clear the CMOS values, use a metal object like a screwdriver to touch the two pins for a few seconds.

 Open: Normal

 Short: Clear CMOS Values



- Always turn off your computer and unplug the power cord from the power outlet before clearing the CMOS values.
- After system restart, go to BIOS Setup to load factory defaults (select Load Optimized Defaults) or manually configure the BIOS settings (refer to Chapter 2, "BIOS Setup," for BIOS configurations).

21) CPU/VGA/DRAM/BOOT (Status LEDs)

The status LEDs show whether the CPU, graphics card, memory, and operating system are working properly after system power-on. If the CPU/VGA/DRAM LED is on, that means the corresponding device is not working normally; if the BOOT LED is on, that means you haven't entered the operating system yet.



CPU	DRAM
VGA	BOOT

CPU: CPU status LED

VGA: Graphics card status LED

DRAM: Memory status LED

BOOT: Operating system status LED

Chapter 2 BIOS Setup

BIOS (Basic Input and Output System) records hardware parameters of the system in the CMOS on the motherboard. Its major functions include conducting the Power-On Self-Test (POST) during system startup, saving system parameters and loading operating system, etc. BIOS includes a BIOS Setup program that allows the user to modify basic system configuration settings or to activate certain system features.

When the power is turned off, the battery on the motherboard supplies the necessary power to the CMOS to keep the configuration values in the CMOS.

To access the BIOS Setup program, press the <Delete> key during the POST when the power is turned on.

To upgrade the BIOS, use either the GIGABYTE Q-Flash or @BIOS utility.

- Q-Flash allows the user to quickly and easily upgrade or back up BIOS without entering the operating system.
- @BIOS is a Windows-based utility that searches and downloads the latest version of BIOS from the Internet and updates the BIOS.



- Because BIOS flashing is potentially risky, if you do not encounter problems using the current version of BIOS, it is recommended that you not flash the BIOS. To flash the BIOS, do it with caution. Inadequate BIOS flashing may result in system malfunction.
- It is recommended that you not alter the default settings (unless you need to) to prevent system instability or other unexpected results. Inadequately altering the settings may result in system's failure to boot. If this occurs, try to clear the CMOS values and reset the board to default values. (Refer to the "Load Optimized Defaults" section in this chapter or introductions of the battery/clear CMOS jumper in Chapter 1 for how to clear the CMOS values.)

2-1 Startup Screen

The following startup Logo screen will appear when the computer boots.

(Sample BIOS Version: D2)



There are two different BIOS modes as follows and you can use the <F2> key to switch between the two modes. The Classic Setup mode provides detailed BIOS settings. You can press the arrow keys on your keyboard to move among the items and press <Enter> to accept or enter a sub-menu. Or you can use your mouse to select the item you want. Easy Mode allows users to quickly view their current system information or to make adjustments for optimum performance. In Easy Mode, you can use your mouse to move through configuration items.



- When the system is not stable as usual, select the **Load Optimized Defaults** item to set your system to its defaults.
- The BIOS Setup menus described in this chapter are for reference only and may differ by BIOS version.

2-2 M.I.T.



Whether the system will work stably with the overclock/overvoltage settings you made is dependent on your overall system configurations. Incorrectly doing overclock/overvoltage may result in damage to CPU, chipset, or memory and reduce the useful life of these components. This page is for advanced users only and we recommend you not to alter the default settings to prevent system instability or other unexpected results. (Inadequately altering the settings may result in system's failure to boot. If this occurs, clear the CMOS values and reset the board to default values.)

► Advanced Frequency Settings

☞ CPU Base Clock

Allows you to manually set the CPU base clock in 0.01 MHz increments. (Default: Auto)

Important: It is highly recommended that the CPU frequency be set in accordance with the CPU specifications.

☞ Host Clock Value

This value changes with the **CPU Base Clock** setting.

☞ Graphics Slice Ratio ^(Note)

Allows you to set the Graphics Slice Ratio.

☞ Graphics UnSlice Ratio ^(Note)

Allows you to set the Graphics UnSlice Ratio.

☞ CPU Upgrade ^(Note)

Allows you to set the CPU frequency. Options may vary depending on the CPU being used. (Default: Auto)

☞ CPU Clock Ratio

Allows you to alter the clock ratio for the installed CPU. The adjustable range is dependent on the CPU being installed.

☞ CPU Frequency

Displays the current operating CPU frequency.

☞ FCLK Frequency for Early Power On

Allows you to set the FCLK frequency. Options are: Normal(800Mhz), 1GHz, 400MHz. (Default: 1GHz)

(Note) This item is present only when you install a CPU that supports this feature. For more information about Intel® CPUs' unique features, please visit Intel's website.

▶ **Advanced CPU Core Settings**

☞ **CPU Clock Ratio, CPU Frequency, FCLK Frequency for Early Power On**

The settings above are synchronous to those under the same items on the **Advanced Frequency Settings** menu.

☞ **AVX Offset** ^(Note)

AVX offset is the negative offset of AVX ratio.

☞ **Uncore Ratio**

Allows you to set the CPU Uncore ratio. The adjustable range is dependent on the CPU being used.

☞ **Uncore Frequency**

Displays the current CPU Uncore frequency.

☞ **CPU Flex Ratio Override**

Enables or disables the CPU Flex Ratio. The maximum CPU clock ratio will be based on the **CPU Flex Ratio Settings** value if **CPU Clock Ratio** is set to **Auto**. (Default: Disabled)

☞ **CPU Flex Ratio Settings**

Allows you to set the CPU Flex Ratio. The adjustable range may vary by CPU.

☞ **Intel(R) Turbo Boost Technology** ^(Note)

Allows you to determine whether to enable the Intel® CPU Turbo Boost technology. **Auto** lets the BIOS automatically configure this setting. (Default: Auto)

☞ **Turbo Ratio** ^(Note)

Allows you to set the CPU Turbo ratios for different number of active cores. **Auto** sets the CPU Turbo ratios according to the CPU specifications. (Default: Auto)

☞ **Power Limit TDP (Watts) / Power Limit Time**

Allows you to set the power limit for CPU Turbo mode and how long it takes to operate at the specified power limit. If the specified value is exceeded, the CPU will automatically reduce the core frequency in order to reduce the power. **Auto** sets the power limit according to the CPU specifications. (Default: Auto)

☞ **Core Current Limit (Amps)**

Allows you to set a current limit for CPU Turbo mode. When the CPU current exceeds the specified current limit, the CPU will automatically reduce the core frequency in order to reduce the current. **Auto** sets the power limit according to the CPU specifications. (Default: Auto)

☞ **Turbo Per Core Limit Control** ^(Note)

Allows you to control each CPU core limit separately. (Default: Auto)

☞ **No. of CPU Cores Enabled** ^(Note)

Allows you to select the number of CPU cores to enable in an Intel® multi-core CPU (the number of CPU cores may vary by CPU). **Auto** lets the BIOS automatically configure this setting. (Default: Auto)

☞ **Hyper-Threading Technology** ^(Note)

Allows you to determine whether to enable multi-threading technology when using an Intel® CPU that supports this function. This feature only works for operating systems that support multi-processor mode. **Auto** lets the BIOS automatically configure this setting. (Default: Auto)

☞ **Intel(R) Speed Shift Technology (Intel® Speed Shift Technology)** ^(Note)

Enables or disables Intel® Speed Shift Technology. Enabling this feature allows the processor to ramp up its operating frequency more quickly and then improves the system responsiveness. (Default: Disabled)

☞ **CPU Enhanced Halt (C1E)** ^(Note)

Enables or disables Intel® CPU Enhanced Halt (C1E) function, a CPU power-saving function in system halt state. When enabled, the CPU core frequency and voltage will be reduced during system halt state to decrease power consumption. **Auto** lets the BIOS automatically configure this setting. (Default: Auto)

(Note) This item is present only when you install a CPU that supports this feature. For more information about Intel® CPUs' unique features, please visit Intel's website.

- ☞ **C3 State Support** ^(Note)
 Allows you to determine whether to let the CPU enter C3 mode in system halt state. When enabled, the CPU core frequency and voltage will be reduced during system halt state to decrease power consumption. The C3 state is a more enhanced power-saving state than C1. **Auto** lets the BIOS automatically configure this setting. (Default: Auto)
- ☞ **C6/C7 State Support** ^(Note)
 Allows you to determine whether to let the CPU enter C6/C7 mode in system halt state. When enabled, the CPU core frequency and voltage will be reduced during system halt state to decrease power consumption. The C6/C7 state is a more enhanced power-saving state than C3. **Auto** lets the BIOS automatically configure this setting. (Default: Auto)
- ☞ **C8 State Support** ^(Note)
 Allows you to determine whether to let the CPU enter C8 mode in system halt state. When enabled, the CPU core frequency and voltage will be reduced during system halt state to decrease power consumption. The C8 state is a more enhanced power-saving state than C6/C7. **Auto** lets the BIOS automatically configure this setting. (Default: Auto)
- ☞ **C10 State Support** ^(Note)
 Allows you to determine whether to let the CPU enter C10 mode in system halt state. When enabled, the CPU core frequency and voltage will be reduced during system halt state to decrease power consumption. The C10 state is a more enhanced power-saving state than C8. **Auto** lets the BIOS automatically configure this setting. (Default: Disabled)
- ☞ **Package C State Limit** ^(Note)
 Allows you to specify the C-state limit for the processor. **Auto** lets the BIOS automatically configure this setting. (Default: Auto)
- ☞ **CPU Thermal Monitor** ^(Note)
 Enables or disables Intel® Thermal Monitor function, a CPU overheating protection function. When enabled, the CPU core frequency and voltage will be reduced when the CPU is overheated. **Auto** lets the BIOS automatically configure this setting. (Default: Auto)
- ☞ **Ring to Core offset (Down Bin)**
 Allows you to determine whether to disable the CPU Ring ratio auto-down function. **Auto** lets the BIOS automatically configure this setting. (Default: Auto)
- ☞ **CPU EIST Function** ^(Note)
 Enables or disables Enhanced Intel® Speed Step Technology (EIST). Depending on CPU loading, Intel® EIST technology can dynamically and effectively lower the CPU voltage and core frequency to decrease average power consumption and heat production. **Auto** lets the BIOS automatically configure this setting. (Default: Auto)
- ☞ **Race To Halt (RTH)** ^(Note)/**Energy Efficient Turbo** ^(Note)
 Enables or disables the CPU power saving related settings.
- ☞ **Voltage Optimization**
 Allows you to determine whether to enable voltage optimization to reduce power consumption. (Default: Auto)
- ☞ **Hardware Prefetcher**
 Allows you to determine whether to enable hardware prefetcher to prefetch data and instructions from the memory into the cache. (Default: Auto)
- ☞ **Adjacent Cache Line Prefetch**
 Allows you to determine whether to enable the adjacent cache line prefetch mechanism that lets the processor retrieve the requested cache line as well as the subsequent cache line. (Default: Auto)

(Note) This item is present only when you install a CPU that supports this feature. For more information about Intel® CPUs' unique features, please visit Intel's website.

- ☞ **Extreme Memory Profile (X.M.P.)** ^(Note)
 Allows the BIOS to read the SPD data on XMP memory module(s) to enhance memory performance when enabled.

 - ▶▶ Disabled Disables this function. (Default)
 - ▶▶ Profile1 Uses Profile 1 settings.
 - ▶▶ Profile2 ^(Note) Uses Profile 2 settings.
- ☞ **System Memory Multiplier**
 Allows you to set the system memory multiplier. **Auto** sets memory multiplier according to memory SPD data. (Default: Auto)
- ☞ **Memory Ref Clock**
 Allows you to manually adjust the memory reference clock. (Default: Auto)
- ☞ **Memory Odd Ratio(100/133 or 200/266)**
Enabled allows Qclk to run in odd frequency. (Default: Auto)
- ☞ **Memory Frequency (MHz)**
 The first memory frequency value is the normal operating frequency of the memory being used; the second is the memory frequency that is automatically adjusted according to the **System Memory Multiplier** settings.
- ▶ **Advanced Memory Settings**
- ☞ **Extreme Memory Profile (X.M.P.)** ^(Note), **System Memory Multiplier**, **Memory Ref Clock**, **Memory Odd Ratio (100/133 or 200/266)**, **Memory Frequency(MHz)**
 The settings above are synchronous to those under the same items on the **Advanced Frequency Settings** menu.
- ☞ **Memory Boot Mode** ^(Note)
 Provides memory detection and training methods.

 - ▶▶ Auto Lets the BIOS automatically configure this setting. (Default)
 - ▶▶ Normal The BIOS automatically performs memory training. Please note that if the system becomes unstable or unbootable, try to clear the CMOS values and reset the board to default values. (Refer to the introductions of the battery/clear CMOS jumper in Chapter 1 for how to clear the CMOS values.)
 - ▶▶ Enable Fast Boot Skip memory detection and training in some specific criteria for faster memory boot.
 - ▶▶ Disable Fast Boot Detect and train memory at every single boot.
- ☞ **Realtime Memory Timing**
 Allows you to fine-tune memory timings after the BIOS stage. (Default: Auto)
- ☞ **Memory Enhancement Settings**
 Provides several memory performance enhancement settings: Normal (basic performance), Relax OC, Enhanced Stability, and Enhanced Performance. (Default: Normal)
- ☞ **Memory Timing Mode**
Manual and **Advanced Manual** allows the **Memory Multiplier Tweaker**, **Channel Interleaving**, **Rank Interleaving**, and memory timing settings below to be configurable. Options are: Auto (default), Manual, Advanced Manual.
- ☞ **Profile DDR Voltage**
 When using a non-XMP memory module or **Extreme Memory Profile (X.M.P.)** is set to **Disabled**, the value is displayed according to your memory specification. When **Extreme Memory Profile (X.M.P.)** is set to **Profile1** or **Profile2**, the value is displayed according to the SPD data on the XMP memory.
- ☞ **Memory Multiplier Tweaker**
 Provides different levels of memory auto-tuning. (Default: Auto)

(Note) This item is present only when you install a CPU and a memory module that support this feature.

☞ **Channel Interleaving**

Enables or disables memory channel interleaving. **Enabled** allows the system to simultaneously access different channels of the memory to increase memory performance and stability. **Auto** lets the BIOS automatically configure this setting. (Default: Auto)

☞ **Rank Interleaving**

Enables or disables memory rank interleaving. **Enabled** allows the system to simultaneously access different ranks of the memory to increase memory performance and stability. **Auto** lets the BIOS automatically configure this setting. (Default: Auto)

▶ **Channel A/B Memory Sub Timings**

This sub-menu provides memory timing settings for each channel of memory. The respective timing setting screens are configurable only when **Memory Timing Mode** is set to **Manual** or **Advanced Manual**. Note: Your system may become unstable or fail to boot after you make changes on the memory timings. If this occurs, please reset the board to default values by loading optimized defaults or clearing the CMOS values.

▶ **Advanced Voltage Settings**

▶ **Advanced Power Settings**

☞ **CPU Vcore Loadline Calibration**

Allows you to configure Load-Line Calibration for the CPU Vcore voltage. Selecting a higher level keeps the CPU Vcore voltage more consistent with what is set in BIOS under heavy load. **Auto** lets the BIOS automatically configure this setting and sets the voltage following Intel's specifications. (Default: Auto)

☞ **VAXG Loadline Calibration**

Allows you to configure Load-Line Calibration for the CPU VAXG voltage. Selecting a higher level keeps the CPU VAXG voltage more consistent with what is set in BIOS under heavy load. **Auto** lets the BIOS automatically configure this setting and sets the voltage following Intel's specifications. (Default: Auto)

▶ **CPU Core Voltage Control**

This section provides CPU voltage control options.

▶ **Chipset Voltage Control**

This section provides Chipset voltage control options.

▶ **DRAM Voltage Control**

This section provides memory voltage control options.

▶ **Internal VR Control**

This section provides VR voltage control options.

▶ **PC Health Status**

☞ **Reset Case Open Status**

- ▶ Disabled Keeps or clears the record of previous chassis intrusion status. (Default)
- ▶ Enabled Clears the record of previous chassis intrusion status and the **Case Open** field will show "No" at next boot.

☞ **Case Open**

Displays the detection status of the chassis intrusion detection device attached to the motherboard CI header. If the system chassis cover is removed, this field will show "Yes", otherwise it will show "No". To clear the chassis intrusion status record, set **Reset Case Open Status** to **Enabled**, save the settings to the CMOS, and then restart your system.

- ⊞ **CPU Vcore/CPU VCCSA/DRAM Channel A/B Voltage/+3.3V/+5V/+12V/CPU VAXG**
Displays the current system voltages.
- ▶ **Miscellaneous Settings**
- ⊞ **Max Link Speed**
Allows you to set the operation mode of the PCI Express slots to Gen 1, Gen 2, or Gen 3. Actual operation mode is subject to the hardware specification of each slot. **Auto** lets the BIOS automatically configure this setting. (Default: Auto)
- ⊞ **3DMark01 Enhancement**
Allows you to determine whether to enhance some legacy benchmark performance. (Default: Disabled)
- ▶ **Smart Fan 5 Settings**
- ⊞ **Monitor**
Allows you to select a target to monitor and to make further adjustment. (Default: CPU FAN)
- ⊞ **Fan Speed Control**
Allows you to determine whether to enable the fan speed control function and adjust the fan speed.
 - ▶▶ Normal Allows the fan to run at different speeds according to the temperature. You can adjust the fan speed with System Information Viewer based on your system requirements. (Default)
 - ▶▶ Silent Allows the fan to run at slow speeds.
 - ▶▶ Manual Allows you to control the fan speed in the curve graph.
 - ▶▶ Full Speed Allows the fan to run at full speeds.
- ⊞ **Fan Control Use Temperature Input**
Allows you to select the reference temperature for fan speed control.
- ⊞ **Temperature Interval**
Allows you to select the temperature interval for fan speed change.
- ⊞ **Fan/Pump Control Mode**
 - ▶▶ Auto Lets the BIOS automatically detect the type of fan/pump installed and sets the optimal control mode. (Default)
 - ▶▶ Voltage Voltage mode is recommended for a 3-pin fan/pump.
 - ▶▶ PWM PWM mode is recommended for a 4-pin fan/pump.
- ⊞ **Fan/Pump Stop**
Enables or disables the fan/pump stop function. You can set the temperature limit using the temperature curve. The fan or pump stops operation when the temperature is lower than the limit. (Default: Disabled)
- ⊞ **Temperature**
Displays the current temperature of the selected target area.
- ⊞ **Fan Speed**
Displays current fan/pump speeds.
- ⊞ **Flow Rate**
Displays the flow rate of your water cooling system.
- ⊞ **Temperature Warning Control**
Sets the warning threshold for temperature. When temperature exceeds the threshold, BIOS will emit warning sound. Options are: Disabled (default), 60°C/140°F, 70°C/158°F, 80°C/176°F, 90°C/194°F.
- ⊞ **Fan/Pump Fail Warning**
Allows the system to emit warning sound if the fan/pump is not connected or fails. Check the fan/pump condition or fan/pump connection when this occurs. (Default: Disabled)

2-3 System



This section provides information on your motherboard model and BIOS version. You can also select the default language used by the BIOS and manually set the system time.

☞ Access Level

Displays the current access level depending on the type of password protection used. (If no password is set, the default will display as **Administrator**.) The Administrator level allows you to make changes to all BIOS settings; the User level only allows you to make changes to certain BIOS settings but not all.

☞ System Language

Selects the default language used by the BIOS.

☞ System Date

Sets the system date. The date format is week (read-only), month, date, and year. Use <Enter> to switch between the Month, Date, and Year fields and use the <Page Up> or <Page Down> key to set the desired value.

☞ System Time

Sets the system time. The time format is hour, minute, and second. For example, 1 p.m. is 13:00:00. Use <Enter> to switch between the Hour, Minute, and Second fields and use the <Page Up> or <Page Down> key to set the desired value.

2-4 BIOS



- **Bootup NumLock State**
Enables or disables Numlock feature on the numeric keypad of the keyboard after the POST. (Default: On)
- **Security Option**
Specifies whether a password is required every time the system boots, or only when you enter BIOS Setup. After configuring this item, set the password(s) under the **Administrator Password/User Password** item.
 - Setup A password is only required for entering the BIOS Setup program.
 - System A password is required for booting the system and for entering the BIOS Setup program. (Default)
- **Full Screen LOGO Show**
Allows you to determine whether to display the GIGABYTE Logo at system startup. **Disabled** skips the GIGABYTE Logo when the system starts up. (Default: Enabled)
- **Boot Option Priorities**
Specifies the overall boot order from the available devices. Removable storage devices that support GPT format will be prefixed with "UEFI:" string on the boot device list. To boot from an operating system that supports GPT partitioning, select the device prefixed with "UEFI:" string.
Or if you want to install an operating system that supports GPT partitioning such as Windows 10 64-bit, select the optical drive that contains the Windows 10 64-bit installation disk and is prefixed with "UEFI:" string.
- **Hard Drive/CD/DVD ROM Drive/Floppy Drive/Network Device BBS Priorities**
Specifies the boot order for a specific device type, such as hard drives, optical drives, floppy disk drives, and devices that support Boot from LAN function, etc. Press <Enter> on this item to enter the submenu that presents the devices of the same type that are connected. This item is present only if at least one device for this type is installed.
- **Fast Boot**
Enables or disables Fast Boot to shorten the OS boot process. **Ultra Fast** provides the fastest bootup speed. (Default: Disabled)

☞ **SATA Support**

- ▶▶ All Sata Devices All SATA devices are functional in the operating system and during the POST. (Default)
- ▶▶ Last Boot HDD Only Except for the previous boot drive, all SATA devices are disabled before the OS boot process completes.

This item is configurable only when **Fast Boot** is set to **Enabled** or **Ultra Fast**.

☞ **VGA Support**

Allows you to select which type of operating system to boot.

- ▶▶ Auto Enables legacy option ROM only.
- ▶▶ EFI Driver Enables EFI option ROM. (Default)

This item is configurable only when **Fast Boot** is set to **Enabled** or **Ultra Fast**.

☞ **USB Support**

- ▶▶ Disabled All USB devices are disabled before the OS boot process completes.
- ▶▶ Full Initial All USB devices are functional in the operating system and during the POST.
- ▶▶ Partial Initial Part of the USB devices are disabled before the OS boot process completes. (Default)

This item is configurable only when **Fast Boot** is set to **Enabled**. This function is disabled when **Fast Boot** is set to **Ultra Fast**.

☞ **PS2 Devices Support**

- ▶▶ Disabled All PS/2 devices are disabled before the OS boot process completes.
- ▶▶ Enabled All PS/2 devices are functional in the operating system and during the POST. (Default)

This item is configurable only when **Fast Boot** is set to **Enabled**. This function is disabled when **Fast Boot** is set to **Ultra Fast**.

☞ **NetWork Stack Driver Support**

- ▶▶ Disabled Disables booting from the network. (Default)
- ▶▶ Enabled Enables booting from the network.

This item is configurable only when **Fast Boot** is set to **Enabled** or **Ultra Fast**.

☞ **Next Boot After AC Power Loss**

- ▶▶ Normal Boot Enables normal bootup upon the return of the AC power. (Default)
- ▶▶ Fast Boot Keeps the Fast Boot settings upon the return of the AC power.

This item is configurable only when **Fast Boot** is set to **Enabled** or **Ultra Fast**.

☞ **Mouse Speed**

Allows you to set the mouse cursor movement speed. (Default: 1 X)

☞ **CSM Support**

Enables or disables UEFI CSM (Compatibility Support Module) to support a legacy PC boot process.

- ▶▶ Enabled Enables UEFI CSM. (Default)
- ▶▶ Disabled Disables UEFI CSM and supports UEFI BIOS boot process only.

☞ **LAN PXE Boot Option ROM**

Allows you to select whether to enable the legacy option ROM for the LAN controller. (Default: Disabled)

This item is configurable only when **CSM Support** is set to **Enabled**.

☞ **Storage Boot Option Control**

Allows you to select whether to enable the UEFI or legacy option ROM for the storage device controller.

- ▶▶ Do not launch Disables option ROM.
- ▶▶ UEFI Enables UEFI option ROM only. (Default)
- ▶▶ Legacy Enables legacy option ROM only.

This item is configurable only when **CSM Support** is set to **Enabled**.

☞ **Other PCI devices**

Allows you to select whether to enable the UEFI or Legacy option ROM for the PCI device controller other than the LAN, storage device, and graphics controllers.

- ▶▶ Do not launch Disables option ROM.
- ▶▶ UEFI Enables UEFI option ROM only. (Default)
- ▶▶ Legacy Enables legacy option ROM only.

This item is configurable only when **CSM Support** is set to **Enabled**.

☞ **Administrator Password**

Allows you to configure an administrator password. Press <Enter> on this item, type the password, and then press <Enter>. You will be requested to confirm the password. Type the password again and press <Enter>. You must enter the administrator password (or user password) at system startup and when entering BIOS Setup. Differing from the user password, the administrator password allows you to make changes to all BIOS settings.

☞ **User Password**

Allows you to configure a user password. Press <Enter> on this item, type the password, and then press <Enter>. You will be requested to confirm the password. Type the password again and press <Enter>. You must enter the administrator password (or user password) at system startup and when entering BIOS Setup. However, the user password only allows you to make changes to certain BIOS settings but not all.

To cancel the password, press <Enter> on the password item and when requested for the password, enter the correct one first. When prompted for a new password, press <Enter> without entering any password. Press <Enter> again when prompted to confirm.

NOTE: Before setting the User Password, be sure to set the Administrator Password first.

2-5 Peripherals



Initial Display Output

Specifies the first initiation of the monitor display from the installed PCI Express graphics card or the onboard graphics.

- ▶▶ IGFX Sets the onboard graphics as the first display.
- ▶▶ PCIe 1 Slot Sets the graphics card on the PCIEX16 slot as the first display. (Default)
- ▶▶ PCIe 2 Slot Sets the graphics card on the PCIEX4 slot as the first display.

EZ RAID

Allows you to quickly set up a RAID array. Refer to Chapter 3, "Configuring a RAID Set," for instructions on configuring a RAID array.

Above 4G Decoding

Enables or disables 64-bit capable devices to be decoded in above 4 GB address space (only if your system supports 64-bit PCI decoding). Set to Enabled if more than one advanced graphics card are installed and their drivers are not able to be launched when entering the operating system (because of the limited 4 GB memory address space). (Default: Disabled)

RGB Fusion

Allows you to set the LED lighting mode for the motherboard.

- ▶▶ Off Disables this function.
- ▶▶ Pulse Mode All LEDs simultaneously fade in and fade out.
- ▶▶ Color Cycle All LEDs simultaneously cycle through a full spectrum of colors.
- ▶▶ Static Mode All LEDs emit a single color. (Default)
- ▶▶ Flash Mode All LEDs simultaneously flash on and off.
- ▶▶ Double Flash All LEDs flash in an interlaced pattern.

LEDs in Sleep, Hibernation, and Soft Off States

Allows you to set the lighting mode of the motherboard LEDs in system S3/S4/S5 state.

This feature is supported only with a 5V digital LED strip.

- ▶▶ Off Disables the selected lighting mode when the system enters S3/S4/S5 state. (Default)
- ▶▶ On Enables the selected lighting mode when the system enters S3/S4/S5 state.

- ☞ **Intel Platform Trust Technology (PTT)**
Enables or disables Intel® PTT Technology. (Default: Disabled)
- ☞ **SW Guard Extensions (SGX)**
Enables or disables the Intel® Software Guard Extensions technology. This feature allows legal software to operate in a safe environment and protects the software against attacks from malicious software. The **Software Controlled** option allows you to enable or disable this feature with an Intel-provided application. (Default: Software Controlled)

- ▶ **Intel(R) Ethernet Connection**
This sub-menu provides information on LAN configuration and related configuration options.
- ▶ **OffBoard SATA Controller Configuration**
Displays information on your M.2 PCIe SSD if installed.
- ▶ **Trusted Computing**
Enables or disables Trusted Platform Module (TPM).
- ▶ **Intel(R) Bios Guard Technology**
Enables or disables the Intel® BIOS Guard feature, which protects the BIOS from malicious attacks.

- ▶ **Network Stack Configuration**
 - ☞ **Network Stack**
Disables or enables booting from the network to install a GPT format OS, such as installing the OS from the Windows Deployment Services server. (Default: Disabled)
 - ☞ **Ipv4 PXE Support**
Enables or disables IPv4 PXE Support. This item is configurable only when **Network Stack** is enabled.
 - ☞ **Ipv4 HTTP Support**
Enables or disables HTTP boot support for IPv4. This item is configurable only when **Network Stack** is enabled.
 - ☞ **Ipv6 PXE Support**
Enables or disables IPv6 PXE Support. This item is configurable only when **Network Stack** is enabled.
 - ☞ **Ipv6 HTTP Support**
Enables or disables HTTP boot support for IPv6. This item is configurable only when **Network Stack** is enabled.
 - ☞ **IP6 Configuration Policy**
Allows you to change IP6 Configuration Policy to Automatic or Manual. This item is configurable only when **Network Stack** is enabled.
 - ☞ **PXE boot wait time**
Allows you to configure how long to wait before you can press <Esc> to abort the PXE boot. This item is configurable only when **Network Stack** is enabled. (Default: 0)
 - ☞ **Media detect count**
Allows you to set the number of times to check the presence of media. This item is configurable only when **Network Stack** is enabled. (Default: 1)

- ▶ **NVMe Configuration**
Displays information on your M.2 NVMe PCIe SSD if installed.

▶ **USB Configuration**

☞ **Legacy USB Support**

Allows USB keyboard/mouse to be used in MS-DOS. (Default: Enabled)

☞ **XHCI Hand-off**

Determines whether to enable XHCI Hand-off feature for an operating system without XHCI Hand-off support. (Default: Disabled)

☞ **USB Mass Storage Driver Support**

Enables or disables support for USB storage devices. (Default: Enabled)

☞ **Port 60/64 Emulation**

Enables or disables emulation of I/O ports 64h and 60h. This should be enabled for full legacy support for USB keyboards/mice in MS-DOS or in operating system that does not natively support USB devices. (Default: Enabled)

☞ **Mass Storage Devices**

Displays a list of connected USB mass storage devices. This item appears only when a USB storage device is installed.

▶ **SATA And RST Configuration**

☞ **SATA Controller(s)**

Enables or disables the integrated SATA controllers. (Default: Enabled)

☞ **SATA Mode Selection**

Enables or disables RAID for the SATA controllers integrated in the Chipset or configures the SATA controllers to AHCI mode.

▶▶ Intel RST Premium With Intel Optane System Acceleration Enables RAID for the SATA controller.

▶▶ AHCI Configures the SATA controllers to AHCI mode. Advanced Host Controller Interface (AHCI) is an interface specification that allows the storage driver to enable advanced Serial ATA features such as Native Command Queuing and hot plug. (Default)

☞ **Aggressive LPM Support**

Enables or disables the power saving feature, ALPM (Aggressive Link Power Management), for the Chipset SATA controllers. (Default: Enabled)

☞ **Port 0/1/2/3/4/5**

Enables or disables each SATA port. (Default: Enabled)

☞ **Hot plug**

Enables or disable the hot plug capability for each SATA port. (Default: Disabled)

☞ **Configured as eSATA**

Enables or disables support for external SATA devices.

☞ **Mechanical Presence Switch**

Allows you to determine whether to turn on the Mechanical Presence switch for the SATA device. This item is configurable only when **Hot plug** is enabled. (Default: Enabled)

2-6 Chipset



- **VT-d (Note)**
Enables or disables Intel® Virtualization Technology for Directed I/O. (Default: Enabled)
- **Internal Graphics**
Enables or disables the onboard graphics function. (Default: Auto)
- **DVMT Pre-Allocated**
Allows you to set the onboard graphics memory size. Options are: 32M~1024M. (Default: 64M)
- **DVMT Total Gfx Mem**
Allows you to allocate the DVMT memory size of the onboard graphics. Options are: 128M, 256M, MAX. (Default: 256M)
- **Audio Controller**
Enables or disables the onboard audio function. (Default: Enabled)
If you wish to install a 3rd party add-in audio card instead of using the onboard audio, set this item to **Disabled**.
- **PCH LAN Controller**
Enables or disables the onboard LAN function. (Default: Enabled)
If you wish to install a 3rd party add-in network card instead of using the onboard LAN, set this item to **Disabled**.
- **Wake on LAN Enable**
Enables or disables the wake on LAN function. (Default: Enabled)
- **High Precision Timer**
Enables or disables High Precision Event Timer (HPET) in the operating system. (Default: Enabled)
- **IOAPIC 24-119 Entries**
Enables or disables this function. (Default: Enabled)

(Note) This item is present only when you install a CPU that supports this feature. For more information about Intel® CPUs' unique features, please visit Intel's website.

2-7 Power



- ☞ **Platform Power Management**
Enables or disables the Active State Power Management function (ASPM). (Default: Disabled)
- ☞ **PEG ASPM**
Allows you to configure the ASPM mode for the device connected to the CPU PEG bus. This item is configurable only when **Platform Power Management** is set to **Enabled**. (Default: Enabled)
- ☞ **PCH ASPM**
Allows you to configure the ASPM mode for the device connected to Chipset's PCI Express bus. This item is configurable only when **Platform Power Management** is set to **Enabled**. (Default: Enabled)
- ☞ **DMI ASPM**
Allows you to configure the ASPM mode for both CPU side and Chipset side of the DMI link. This item is configurable only when **Platform Power Management** is set to **Enabled**. (Default: Enabled)
- ☞ **AC BACK**
Determines the state of the system after the return of power from an AC power loss.
 - ▶▶ Always Off The system stays off upon the return of the AC power. (Default)
 - ▶▶ Always On The system is turned on upon the return of the AC power.
 - ▶▶ Memory The system returns to its last known awake state upon the return of the AC power.
- ☞ **Power On By Keyboard**
Allows the system to be turned on by a PS/2 keyboard wake-up event.
Note: To use this function, you need an ATX power supply providing at least 1A on the +5VSB lead.
 - ▶▶ Disabled Disables this function. (Default)
 - ▶▶ Any Key Press any key to turn on the system.
 - ▶▶ Keyboard 98 Press POWER button on the Windows 98 keyboard to turn on the system.
 - ▶▶ Password Set a password with 1~5 characters to turn on the system.

☞ **Power On Password**

Set the password when **Power On By Keyboard** is set to **Password**.

Press <Enter> on this item and set a password with up to 5 characters and then press <Enter> to accept. To turn on the system, enter the password and press <Enter>.

Note: To cancel the password, press <Enter> on this item. When prompted for the password, press <Enter> again without entering the password to clear the password settings.

☞ **Power On By Mouse**

Allows the system to be turned on by a PS/2 mouse wake-up event.

Note: To use this function, you need an ATX power supply providing at least 1A on the +5VSB lead.

- ▶▶ Disabled Disables this function. (Default)
- ▶▶ Move Move the mouse to turn on the system.
- ▶▶ Double Click Double click on left button on the mouse to turn on the system.

☞ **ErP**

Determines whether to let the system consume least power in S5 (shutdown) state. (Default: Disabled)

Note: When this item is set to **Enabled**, the following functions will become unavailable: Resume by Alarm, PME event wake up, power on by mouse, power on by keyboard, and wake on LAN.

☞ **Soft-Off by PWR-BTTN**

Configures the way to turn off the computer in MS-DOS mode using the power button.

- ▶▶ Instant-Off Press the power button and then the system will be turned off instantly. (Default)
- ▶▶ Delay 4 Sec. Press and hold the power button for 4 seconds to turn off the system. If the power button is pressed for less than 4 seconds, the system will enter suspend mode.

☞ **Resume by Alarm**

Determines whether to power on the system at a desired time. (Default: Disabled)

If enabled, set the date and time as following:

- ▶▶ Wake up day: Turn on the system at a specific time on each day or on a specific day in a month.
- ▶▶ Wake up hour/minute/second: Set the time at which the system will be powered on automatically.

Note: When using this function, avoid inadequate shutdown from the operating system or removal of the AC power, or the settings may not be effective.

☞ **RC6(Render Standby)**

Allows you to determine whether to let the onboard graphics enter standby mode to decrease power consumption. (Default: Enabled)

2-8 Save & Exit



☞ Save & Exit Setup

Press <Enter> on this item and select **Yes**. This saves the changes to the CMOS and exits the BIOS Setup program. Select **No** or press <Esc> to return to the BIOS Setup Main Menu.

☞ Exit Without Saving

Press <Enter> on this item and select **Yes**. This exits the BIOS Setup without saving the changes made in BIOS Setup to the CMOS. Select **No** or press <Esc> to return to the BIOS Setup Main Menu.

☞ Load Optimized Defaults

Press <Enter> on this item and select **Yes** to load the optimal BIOS default settings. The BIOS defaults settings help the system to operate in optimum state. Always load the Optimized defaults after updating the BIOS or after clearing the CMOS values.

☞ Boot Override

Allows you to select a device to boot immediately. Press <Enter> on the device you select and select **Yes** to confirm. Your system will restart automatically and boot from that device.

☞ Save Profiles

This function allows you to save the current BIOS settings to a profile. You can create up to 8 profiles and save as Setup Profile 1~ Setup Profile 8. Press <Enter> to complete. Or you can select **Select File in HDD/FDD/USB** to save the profile to your storage device.

☞ Load Profiles

If your system becomes unstable and you have loaded the BIOS default settings, you can use this function to load the BIOS settings from a profile created before, without the hassles of reconfiguring the BIOS settings. First select the profile you wish to load and then press <Enter> to complete. You can select **Select File in HDD/FDD/USB** to input the profile previously created from your storage device or load the profile automatically created by the BIOS, such as reverting the BIOS settings to the last settings that worked properly (last known good record).

Chapter 3 Appendix

3-1 Configuring a RAID Set

RAID Levels

	RAID 0	RAID 1	RAID 5	RAID 10
Minimum Number of Hard Drives	≥2	2	≥3	4
Array Capacity	Number of hard drives * Size of the smallest drive	Size of the smallest drive	(Number of hard drives - 1) * Size of the smallest drive	(Number of hard drives/2) * Size of the smallest drive
Fault Tolerance	No	Yes	Yes	Yes

Before you begin, please prepare the following items:

- At least two SATA hard drives or SSDs. ^(Note 1) (To ensure optimal performance, it is recommended that you use two hard drives with identical model and capacity). ^(Note 2)
- Windows setup disk.
- Motherboard driver disk.
- A USB thumb drive.

Configuring the Onboard SATA Controller

A. Installing SATA hard drive(s) in your computer

Install the hard drives/SSDs in the Intel® Chipset controlled connectors on the motherboard. Then connect the power connectors from your power supply to the hard drives.

B. Configuring SATA controller mode in BIOS Setup

Make sure to configure the SATA controller mode correctly in system BIOS Setup.

Steps:

1. Go to **Peripherals\SATA And RST Configuration**, make sure **SATA Controller(s)** is enabled. To create RAID, set **SATA Mode Selection** to **Intel RST Premium With Intel Optane System Acceleration**. Then save the settings and restart your computer.
2. To use the EZ RAID feature, follow the steps in "C-1." To configure UEFI RAID, follow the steps in "C-2." To enter the legacy RAID ROM, refer to "C-3" for more information. Finally, save the settings and exit BIOS Setup.



The BIOS Setup menus described in this section may differ from the exact settings for your motherboard. The actual BIOS Setup menu options you will see shall depend on the motherboard you have and the BIOS version.

C-1. Using EZ RAID

GIGABYTE motherboards provide you with the EZ RAID feature, allowing you to quickly configure a RAID array with simplified steps.

Steps:

1. After restarting the computer, enter the BIOS Setup and go to **Peripherals**. Press <Enter> on the **EZ RAID** item. Select the type of hard drives you use for RAID in the **Type** tab and then press <Enter>.
2. Go to the **Mode** tab to select a RAID level. RAID levels supported include RAID 0, RAID 1, RAID 10, and RAID 5 (the selections available depend on the number of the hard drives being installed). Then press <Enter> to move to the **Create** tab. Click **Proceed** to begin.
3. After completing, you'll be brought back to the **Intel(R) Rapid Storage Technology** screen. Under **RAID Volumes** you can see the new RAID volume. To see more detailed information, press <Enter> on the volume to check for information on RAID level, stripe block size, array name, and array capacity, etc.

(Note 1) An M.2 PCIe SSD cannot be used to set up a RAID set either with an M.2 SATA SSD or a SATA hard drive.

(Note 2) Refer to "1-7 Internal Connectors," for the installation notices for the M.2 and SATA connectors.

C-2. UEFI RAID Configuration

Steps:

1. In BIOS Setup, go to **BIOS** and set **CSM Support** to **Disabled**. Save the changes and exit BIOS Setup.
2. After the system reboot, enter BIOS Setup again. Then enter the **Peripherals/Intel(R) Rapid Storage Technology** sub-menu.
3. On the **Intel(R) Rapid Storage Technology** menu, press <Enter> on **Create RAID Volume** to enter the **Create RAID Volume** screen. Enter a volume name with 1~16 letters (letters cannot be special characters) under the **Name** item and press <Enter>. Then, select a RAID level. RAID levels supported include RAID 0, RAID 1, RAID 10, and RAID 5 (the selections available depend on the number of the hard drives being installed). Next, use the down arrow key to move to **Select Disks**.
4. Under **Select Disks** item, select the hard drives to be included in the RAID array. Press the <Space> key on the hard drives to be selected (selected hard drives are marked with "X"). Then set the stripe block size. The stripe block size can be set from 4 KB to 128 KB. Once you have selected the stripe block size, set the volume capacity.
5. After setting the capacity, move to **Create Volume** and press <Enter> to begin.
6. After completing, you'll be brought back to the **Intel(R) Rapid Storage Technology** screen. Under **RAID Volumes** you can see the new RAID volume. To see more detailed information, press <Enter> on the volume to check for information on RAID level, stripe block size, array name, and array capacity, etc.

C-3. Configuring Legacy RAID ROM

Enter the Intel® legacy RAID BIOS setup utility to configure a RAID array. Skip this step and proceed with the installation of Windows operating system for a non-RAID configuration.

Steps:

1. In BIOS Setup, go to **BIOS** and set **CSM Support** to **Enabled** and **Storage Boot Option Control** to **Legacy**. Next, go to **Peripherals/SATA And RST Configuration** and make sure **Use RST Legacy OROM** is set to **Enabled**. Save the changes and exit BIOS Setup. After the POST memory test begins and before the operating system boot begins, look for a message which says "Press <Ctrl-I> to enter Configuration Utility". Press <Ctrl> + <I> to enter the RAID Configuration Utility.
2. After you press <Ctrl> + <I>, the **MAIN MENU** screen will appear. If you want to create a RAID array, select **Create RAID Volume** in **MAIN MENU** and press <Enter>.
3. After entering the **CREATE VOLUME MENU** screen, enter a volume name with 1~16 letters (letters cannot be special characters) under the **Name** item and press <Enter>. Then, select a RAID level. RAID levels supported include RAID 0, RAID 1, RAID 10, and RAID 5 (the selections available depend on the number of the hard drives being installed). Press <Enter> to proceed.
4. Under **Disks** item, select the hard drives to be included in the RAID array. If only two hard drives are installed, they will be automatically assigned to the array. Set the stripe block size if necessary. The stripe block size can be set from 4 KB to 128 KB. Once you have selected the stripe block size, press <Enter>.
5. Enter the array capacity and press <Enter>. Finally press <Enter> on the **Create Volume** item to begin creating the RAID array. When prompted to confirm whether to create this volume, press <Y> to confirm or <N> to cancel.
6. When completed, you can see detailed information about the RAID array in the **DISK/VOLUME INFORMATION** section, including the RAID level, stripe block size, array name, and array capacity, etc. To exit the RAID BIOS utility, press <Esc> or select **6. Exit** in **MAIN MENU**.



Please visit GIGABYTE's website for details on configuring a RAID array.

Installing the SATA RAID/AHCI Driver and Operating System

With the correct BIOS settings, you are ready to install the operating system.

Installing the Operating System

As some operating systems already include Intel® SATA RAID/AHCI driver, you do not need to install separate RAID/AHCI driver during the Windows installation process. After the operating system is installed, we recommend that you install all required drivers from the motherboard driver disk using "Xpress Install" to ensure system performance and compatibility. If the operating system to be installed requires that you provide additional SATA RAID/AHCI driver during the OS installation process, please refer to the steps below:

1. Copy the **IRST** folder under **\Boot** in the driver disk to your USB thumb drive.
2. Boot from the Windows setup disk and perform standard OS installation steps. When the screen requesting you to load the driver appears, select **Browse**.
3. Then browse to the USB flash drive and select the location of the driver. The location of the driver is as follows: **\IRST\6flpy-x64**
4. When a screen as shown, select **Intel Chipset SATA RAID Controller** and click **Next** to load the driver and continue the OS installation.

3-2 Installing an Intel® Optane™ Memory

System Requirements

1. Intel® Optane™ memory
2. The Optane™ memory must have at least 16 GB capacity, and it must have equal or smaller capacity than the hard drive/SSD to be accelerated.
3. The Optane™ memory cannot be used to accelerate an existing RAID array; the accelerated hard drive/SSD cannot be included in a RAID array.
4. The hard drive/SSD to be accelerated must be a SATA hard drive or M.2 SATA SSD and must have Windows 10 64-bit (or later version) installed on it. (Must be formatted for GPT partition.)
5. The motherboard driver disk

Installation Guidelines

A-1: Installation in AHCI mode

If the SATA controller has been configured in AHCI mode, please follow the steps below:

1. After entering the operating system, insert the motherboard driver disk into your optical drive. On the Xpress Install screen, select **Intel(R) Optane(TM) Memory System Acceleration** ^(Note) to install. Follow the on-screen instructions to continue. The system will auto-restart.
2. After re-entering the operating system, the dialog box as shown above will appear. Click **Yes** to continue the installation and then restart the system.
3. Launch the Intel(R) Optane Memory application from the Start menu. A message which says Intel® Optane™ Memory is disabled will appear on the main screen. Click **Enable** to activate the Intel® Optane™ Memory and restart the system again.
4. Launch the Intel(R) Optane Memory application from the Start menu and make sure the Intel® Optane™ Memory has been enabled. (The SATA controller mode is changed to Intel RST Premium With Intel Optane System Acceleration from AHCI mode. DO NOT change your SATA controller mode back to AHCI. Doing so will prevent Intel® Optane™ memory from functioning properly.)

(Note) If the system already has Intel® Rapid Storage Technology utility installed, you have to remove it first before installing the Intel(R) Optane(TM) Memory System Acceleration application.

A-2: Installation in Intel RST Premium With Intel Optane System Acceleration mode

If the SATA controller has been configured in Intel RST Premium With Intel Optane System Acceleration mode, please follow the steps below:

1. After system restarts, go to the BIOS Setup, make sure **CSM Support** under the **BIOS** menu is disabled.
2. Go to **Peripherals\SATA And RST Configuration** and make sure **Use RST Legacy OROM** is disabled. If you want to enable the Optane™ memory installed in the M2Q_32G connector, set **PCIe Storage Dev on Port 21 to RST Controlled**; to enable the Optane™ memory installed in the M2P_32G connector, set **PCIe Storage Dev on Port 9 to RST Controlled**.
3. Enter the operating system, launch the Intel® Rapid Storage Technology utility from the Start menu, and then enable Intel® Optane™ Memory on the **Intel® Optane™ Memory** screen.
4. If you install more than one Optane™ memory, please select which one you are going to use.
5. Follow the on-screen instruction to continue the installation and then restart the system when completed.



- An Optane™ memory cannot be used to accelerate an M.2 PCIe SSD.
- If more than one Optane™ memory is installed, you can select only one of them to accelerate your SATA-based boot drive. The other(s) can only be used as data drive(s).
- Do not abruptly remove the Optane™ memory. Doing so will cause the operating system to stop functioning correctly.
- If you want to change/remove the Optane™ memory, you must disable it using the Intel® Rapid Storage Technology or Intel(R) Optane™ Memory application first.
- After enabling the Optane™ memory, the related BIOS settings will remain even after a BIOS update.

3-3 Drivers Installation



- Before installing the drivers, first install the operating system.
- After installing the operating system, insert the motherboard driver disk into your optical drive. Click on the message "Tap to choose what happens with this disc" on the top-right corner of the screen and select "Run Run.exe." (Or go to My Computer, double-click the optical drive and execute the Run.exe program.)

"Xpress Install" will automatically scan your system and then list all of the drivers that are recommended to install. You can click the **Xpress Install** button and "Xpress Install" will install all of the selected drivers. Or click the arrow  to individually install the drivers you need.

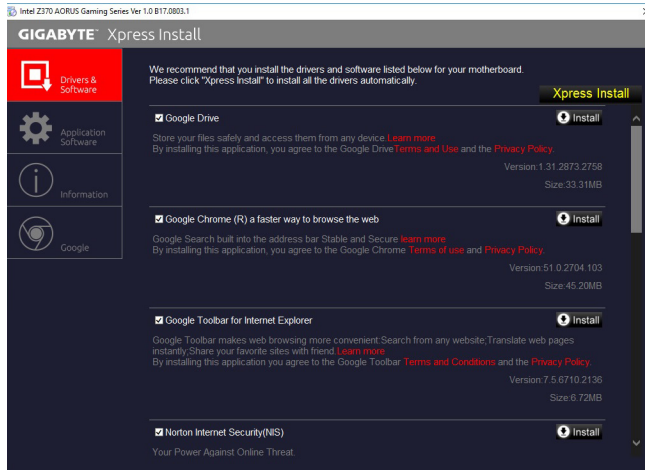

Please visit GIGABYTE's website for more software information.



Please visit GIGABYTE's website for details on configuring the audio software.

Regulatory Statements

Regulatory Notices

This document must not be copied without our written permission, and the contents there of must not be imparted to a third party nor be used for any unauthorized purpose.

Contravention will be prosecuted. We believe that the information contained herein was accurate in all respects at the time of printing. GIGABYTE cannot, however, assume any responsibility for errors or omissions in this text. Also note that the information in this document is subject to change without notice and should not be construed as a commitment by GIGABYTE.

Our Commitment to Preserving the Environment

In addition to high-efficiency performance, all GIGABYTE motherboards fulfill European Union regulations for RoHS (Restriction of Certain Hazardous Substances in Electrical and Electronic Equipment) and WEEE (Waste Electrical and Electronic Equipment) environmental directives, as well as most major worldwide safety requirements. To prevent releases of harmful substances into the environment and to maximize the use of our natural resources, GIGABYTE provides the following information on how you can responsibly recycle or reuse most of the materials in your "end of life" product.

Restriction of Hazardous Substances (RoHS) Directive Statement

GIGABYTE products have not intended to add and safe from hazardous substances (Cd, Pb, Hg, Cr+6, PBDE and PBB). The parts and components have been carefully selected to meet RoHS requirement. Moreover, we at GIGABYTE are continuing our efforts to develop products that do not use internationally banned toxic chemicals.

Waste Electrical & Electronic Equipment (WEEE) Directive Statement

GIGABYTE will fulfill the national laws as interpreted from the 2002/96/EC WEEE (Waste Electrical and Electronic Equipment) directive. The WEEE Directive specifies the treatment, collection, recycling and disposal of electric and electronic devices and their components. Under the Directive, used equipment must be marked, collected separately, and disposed of properly.

WEEE Symbol Statement



The symbol shown below is on the product or on its packaging, which indicates that this product must not be disposed of with other waste. Instead, the device should be taken to the waste collection centers for activation of the treatment, collection, recycling and disposal procedure. The separate collection and recycling of your waste equipment at the time of disposal will help to conserve natural resources and ensure that it is recycled in a manner that protects human health and the environment.

For more information about where you can drop off your waste equipment for recycling, please contact your local government office, your household waste disposal service or where you purchased the product for details of environmentally safe recycling.

- ◆ When your electrical or electronic equipment is no longer useful to you, "take it back" to your local or regional waste collection administration for recycling.
- ◆ If you need further assistance in recycling, reusing in your "end of life" product, you may contact us at the Customer Care number listed in your product's user's manual and we will be glad to help you with your effort.

Finally, we suggest that you practice other environmentally friendly actions by understanding and using the energy-saving features of this product (where applicable), recycling the inner and outer packaging (including shipping containers) this product was delivered in, and by disposing of or recycling used batteries properly. With your help, we can reduce the amount of natural resources needed to produce electrical and electronic equipment, minimize the use of landfills for the disposal of "end of life" products, and generally improve our quality of life by ensuring that potentially hazardous substances are not released into the environment and are disposed of properly.

FCC Notice (U.S.A. Only)

This equipment has been tested and found to comply with the limits for a Class B digital device, pursuant to Part 15 of the FCC Rules. These limits are designed to provide reasonable protection against harmful interference in a residential installation. This equipment generates, uses, and can radiate radio frequency energy and, if not installed and used in accordance with the instructions, may cause harmful interference to radio communications. However, there is no guarantee that interference will not occur in a particular installation. If this equipment does cause harmful interference to radio or television reception, which can be determined by turning the equipment off and on, the user is encouraged to try to correct the interference by one or more of the following measures:

- ◆ Reorient or relocate the receiving antenna.
- ◆ Increase the separation between the equipment and receiver.
- ◆ Connect the equipment into an outlet on a circuit different from that to which the receiver is connected.
- ◆ Consult a dealer or experienced TV/radio technician for help.

Canada, Industry Canada (IC) Notices / Canada, avis d'Industry Canada (IC)

- ◆ This Class B digital apparatus complies with Canadian ICES-003 and RSS-210.
- ◆ Operation is subject to the following two conditions: (1) this device may not cause interference, and (2) this device must accept any interference, including interference that may cause undesired operation of the device.
- ◆ Cet appareil numérique de classe B est conforme aux normes canadiennes ICES-003 et RSS-210.
- ◆ Son fonctionnement est soumis aux deux conditions suivantes : (1) cet appareil ne doit pas causer d'interférence et (2) cet appareil doit accepter toute interférence, notamment les interférences qui peuvent affecter son fonctionnement.

A series of 25 horizontal lines for writing or drawing.



Contact Us

GIGA-BYTE TECHNOLOGY CO., LTD.

Address: No.6, Baoqiang Rd., Xindian Dist., New Taipei City 231, Taiwan

TEL: +886-2-8912-4000, FAX: +886-2-8912-4005

Tech. and Non-Tech. Support (Sales/Marketing) : <http://esupport.gigabyte.com>

WEB address (English): <http://www.gigabyte.com>

WEB address (Chinese): <http://www.gigabyte.tw>

- **GIGABYTE eSupport**

To submit a technical or non-technical (Sales/Marketing) question, please link to:
<http://esupport.gigabyte.com>

The screenshot shows the GIGABYTE eSupport website. At the top left is the GIGABYTE logo. To the right is the 'eSupport' logo. Below these are three icons: 'Downloads', 'FAQ', and 'Warranty'. In the center, there is a 'Sign in with' section featuring social media icons for Facebook, Google+, and a generic user icon. Below this is the 'GIGABYTE Passport' login form, which includes fields for 'E-mail' and 'Password', a 'Login' button, and a 'Forgot password?' link. At the bottom of the page, there is a small copyright notice: 'All intellectual property rights, including without limitation to copyright and trademark of this work and its derivative works are the property of, or are licensed to, GIGA-BYTE TECHNOLOGY CO., LTD. Any unauthorized use is strictly prohibited.'